

# TBA820 • TBA820L

## 2-WATT AUDIO AMPLIFIER

### FAIRCHILD LINEAR INTEGRATED CIRCUITS

**GENERAL DESCRIPTION** – The TBA820 is an integrated monolithic audio amplifier in a 14-pin plastic power package. It is constructed on a single silicon chip using the Fairchild Planar\* epitaxial process. It is intended for use as a low frequency class B amplifier with wide range of supply voltage (3 to 16 V).

The device is supplied in both the quad in-line (TBA820) and the standard dual in-line (TBA820L).

- MINIMUM WORKING VOLTAGE OF 3 V
- LOW QUIESCENT CURRENT
- LOW NUMBER OF EXTERNAL COMPONENTS
- GOOD RIPPLE REJECTION
- NO CROSS-OVER DISTORTION
- TYPICAL OUTPUT POWER:
  - 2 W AT 12 V – 8 Ω
  - 1.6 W AT 9 V – 4 Ω
  - 1.2 W AT 9 V – 8 Ω
  - 0.75 W AT 6 V – 4 Ω

#### ABSOLUTE MAXIMUM RATINGS

Supply Voltage	16 V
Output Peak Current	1.5 A
Power Dissipation at $T_{amb} = 50^{\circ}\text{C}$	1.25 W
Storage and Junction Temperature	$-40^{\circ}\text{C}$ to $150^{\circ}\text{C}$
Pin Temperature (Soldering 10 s)	$260^{\circ}\text{C}$

#### Thermal Data

$\theta_{j-amb}$	Thermal Resistance Junction-Ambient (copper frame) max	$80^{\circ}\text{C}/\text{W}$
------------------	--	-------------------------------

**CONNECTION DIAGRAM**  
**14-PIN POWER DIP**  
 (TOP VIEW)  
 PACKAGE OUTLINE 9A, 9C

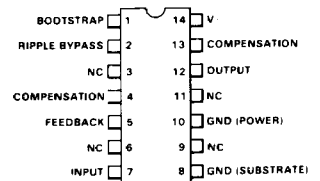

#### ORDER INFORMATION

TYPE	PART NO.
820 (9C)	TBA820
820L (9A)*	TBA820L

\*Recommended for new designs.

#### EQUIVALENT CIRCUIT

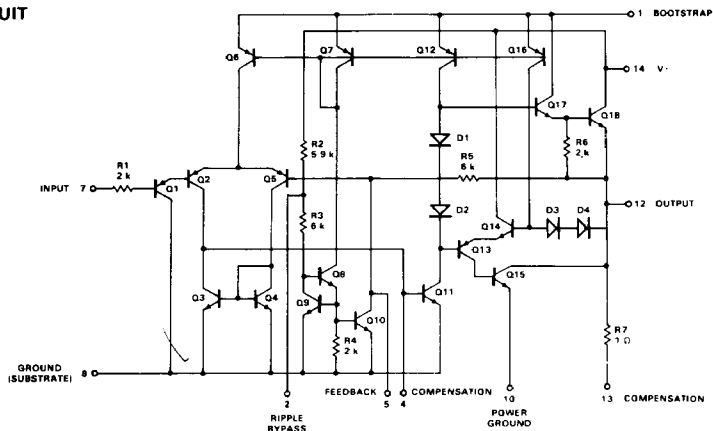

**ELECTRICAL CHARACTERISTICS:** Power output measured at pin 12,  $T_A = 25^\circ\text{C}$  unless otherwise specified.

CHARACTERISTICS	TEST CONDITIONS	MIN	TYP	MAX	UNITS
Supply Voltage		3		16	V
Quiescent Output Voltage (Pin 12)	$V^+ = 9\text{ V}$	4	4.5	5	V
Quiescent Drain Current	$V^+ = 9\text{ V}$		4	12	mA
Bias Current (Pin 7)	$V^+ = 9\text{ V}$		0.1	0.7	$\mu\text{A}$
Power Output, Figure 1	THD = 10%, $R_{FB} = 120\ \Omega$ , $f = 1\text{ kHz}$ , $V^+ = 12\text{ V}$ , $R_L = 8\ \Omega$ $V^+ = 9\text{ V}$ , $R_L = 4\ \Omega$ $V^+ = 9\text{ V}$ , $R_L = 8\ \Omega$ $V^+ = 6\text{ V}$ , $R_L = 4\ \Omega$ $V^+ = 3.5\text{ V}$ , $R_L = 4\ \Omega$	0.9	2 1.6 1.2 0.75 0.22		W W W W W
Input Sensitivity, Figure 1	$P_{OUT} = 1.2\text{ W}$ , $R_L = 8\ \Omega$ , $V^+ = 9\text{ V}$ , $f = 1\text{ kHz}$ $R_{FB} = 33\ \Omega$ $R_{FB} = 120\ \Omega$		16 60		mV mV
Input Sensitivity, Figure 1	$P_{OUT} = 50\text{ mW}$ , $R_L = 8\ \Omega$ , $V^+ = 9\text{ V}$ , $f = 1\text{ kHz}$ $R_{FB} = 33\ \Omega$ $R_{FB} = 120\ \Omega$		3.5 12		mV mV
Input Resistance			5		M $\Omega$
Frequency Response (-3 dB) Figure 1	$V^+ = 9\text{ V}$ , $R_L = 8\ \Omega$ , $R_{FB} = 120\ \Omega$ $C_{FB} = 680\text{ pF}$ $C_{FB} = 220\text{ pF}$		25 - 7000 25 - 20,000		Hz Hz
Total Harmonic Distortion Figure 1	$P_{OUT} = 500\text{ mW}$ , $R_L = 8\ \Omega$ , $V^+ = 9\text{ V}$ , $f = 1\text{ kHz}$ $R_{FB} = 33\ \Omega$ $R_{FB} = 120\ \Omega$		0.8 0.4		% %
Voltage Gain (Open Loop)	$V^+ = 9\text{ V}$ , $R_L = 8\ \Omega$ , $f = 1\text{ kHz}$		75		dB
Voltage Gain (Closed Loop)	$V^+ = 9\text{ V}$ , $R_L = 8\ \Omega$ , $f = 1\text{ kHz}$ $R_{FB} = 33\ \Omega$ $R_{FB} = 120\ \Omega$	31	45 34	37	dB dB
Input Noise Voltage	$V^+ = 9\text{ V}$ , BW (-3.0 dB) = 25-20,000 Hz		3		$\mu\text{V}$
Input Noise Current	$V^+ = 9\text{ V}$ , BW (-3.0 dB) = 25-20,000 Hz		0.4		nA
Signal Plus Noise to Noise Ratio	$V^+ = 9\text{ V}$ , $R_L = 8\ \Omega$ , $R_{FB} = 120\ \Omega$ BW (-3.0 dB) = 25-20,000 Hz $R_1 = 100\text{ k}\Omega$ , $P_{OUT} = 1.2\text{ W}$		70		dB
Supply Voltage Rejection, Figure 2	$V = 9\text{ V}$ , $R_L = 8\ \Omega$ , $f$ (ripple) = 100 Hz, $C_6 = 50\ \mu\text{F}$ , $R_{FB} = 120\ \Omega$		42		dB

4

**TYPICAL PERFORMANCE CURVES**

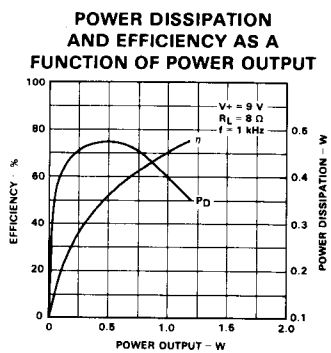
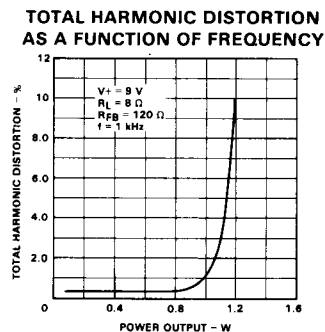
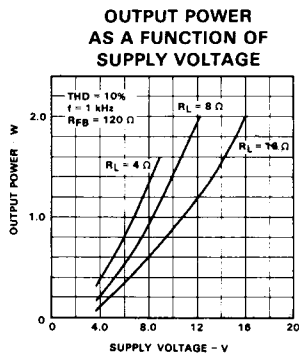

TYPICAL PERFORMANCE CURVES (Cont'd)

MAXIMUM POWER DISSIPATION (SINE WAVE OPERATION) AS A FUNCTION OF SUPPLY VOLTAGE

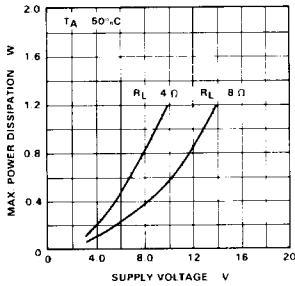

TYPICAL VALUE OF C<sub>FB</sub> AS A FUNCTION OF R<sub>FB</sub>

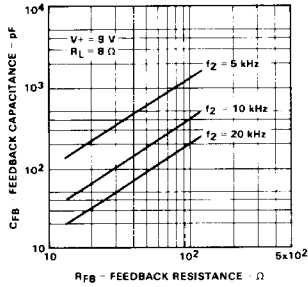

TYPICAL RELATIVE FREQUENCY RESPONSE

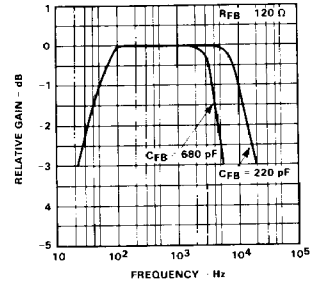

INPUT SENSITIVITY AS A FUNCTION OF R<sub>FB</sub>

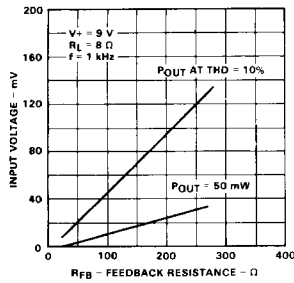

TYPICAL VOLTAGE GAIN (CLOSED LOOP) AS A FUNCTION OF R<sub>FB</sub>

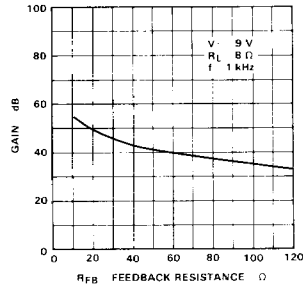

TOTAL HARMONIC DISTORTION AS A FUNCTION OF FREQUENCY

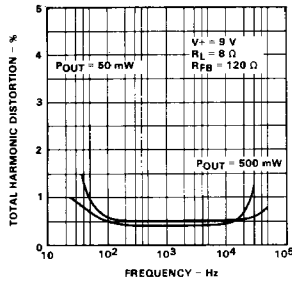

SUPPLY VOLTAGE REJECTION AS A FUNCTION OF R<sub>FB</sub> FOR FIG. 1 CIRCUIT

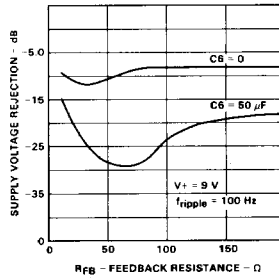

SUPPLY VOLTAGE REJECTION AS A FUNCTION OF R<sub>FB</sub> (FIG. 2 CIRCUIT)

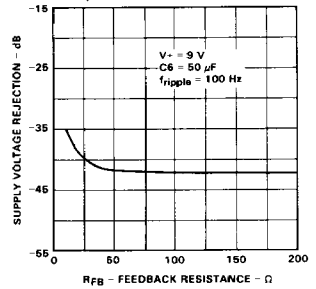

QUIESCENT CURRENT AS A FUNCTION OF SUPPLY VOLTAGE

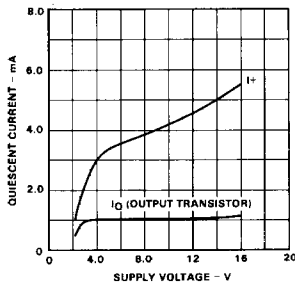

QUIESCENT OUTPUT VOLTAGE AT PIN 12 AS A FUNCTION OF SUPPLY VOLTAGE

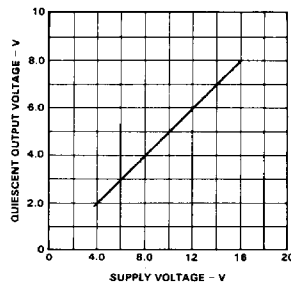

POWER RATING CHART AS A FUNCTION OF AMBIENT TEMPERATURE

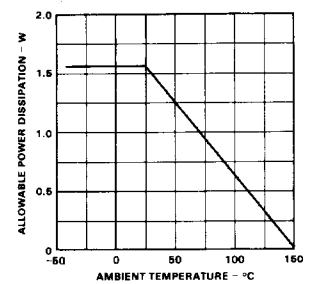

TEST AND APPLICATION CIRCUITS

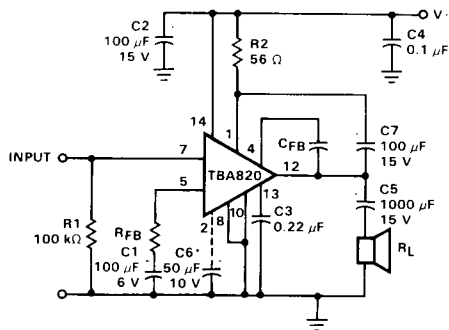
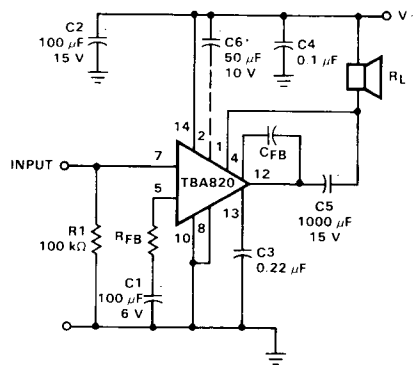

\*Capacitor C6 must be used when high ripple rejection is desired.

Fig. 1. Circuit Diagram with Load Connected to the Supply Voltage

Fig. 2. Circuit Diagram with Load Connected to Ground